

INSTRUCTION MANUAL

ColorPlus 3

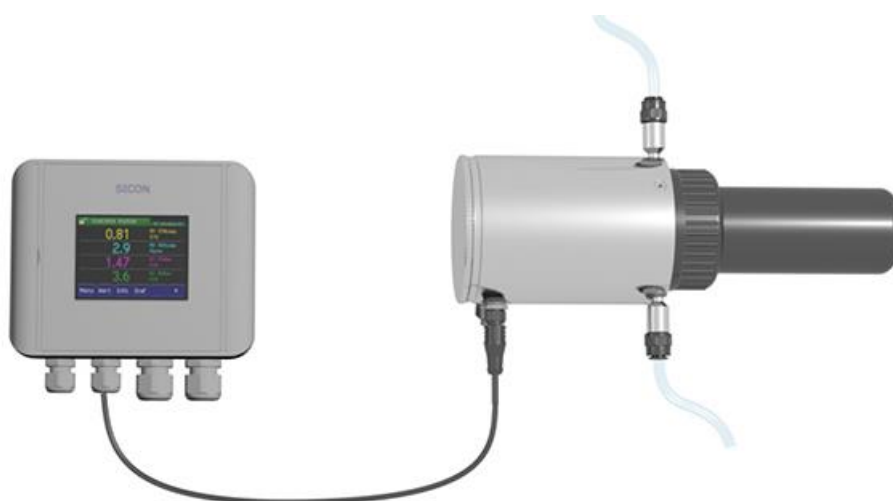

Absorption Measuring Instrument

SIGRIST-PHOTOMETER AG
Hofurlistrasse 1
CH-6373 Ennetbürgen
Switzerland

Tel. +41 41 624 54 54
Fax +41 41 624 54 55
info@photometer.com
www.photometer.com

Contents

- 1 General user information7
 - 1.1 Terms used in this document (glossary)7
 - 1.2 Purpose of the Instruction Manual7
 - 1.3 Target group of the documentation7
 - 1.4 Additional documentation7
 - 1.5 Copyright provisions7
 - 1.6 Document storage location7
 - 1.7 Order document8
 - 1.8 Proper use8
 - 1.9 User requirements8
 - 1.10 Declaration of conformity8
 - 1.11 Use restrictions8
 - 1.12 Dangers when not used properly9
 - 1.13 Meaning of the safety symbols10
 - 1.14 Meaning of the pictograms10
- 2 Instrument overview11
 - 2.1 Overview of a measuring point11
 - 2.2 Designation of the ColorPlus 312
 - 2.3 Scope of supply and accessories13
 - 2.3.1 Standard scope of supply for the ColorPlus 313
 - 2.3.2 Optional accessories for the ColorPlus 314
 - 2.4 Technical data for the ColorPlus 315
- 3 General safety points17
 - 3.1 Dangers when properly used17
 - 3.2 Residual risk18
 - 3.3 Warning and danger symbols on the instrument18
 - 3.4 Preventing undesirable online access attempts19
- 4 Mounting20
 - 4.1 Mounting the ColorPlus 320
 - 4.2 Mounting the SICON (M)21
- 5 Electrical installation22
 - 5.1 Safety pointers for the electrical connection22
 - 5.2 Opening the cover on the SICON (M)23
 - 5.3 Overview of the opened SICON (M) control unit24
 - 5.4 Connecting the SICON (M)25
 - 5.5 Connecting the instrument cable to the ColorPlus 326
 - 5.5.1 Cable cross-sections over longer distances27
 - 5.6 Connecting the connection box28
 - 5.7 Connecting the optional flow meter29
 - 5.8 Connecting the optional 24 VDC power supply30
 - 5.9 Connecting the field bus interfaces (optional)31
 - 5.9.1 Overview of Profibus DP and Modbus RTU31
 - 5.9.2 Connecting the Profibus DP or Modbus RTU31
 - 5.9.3 Overview of Profinet IO32
 - 5.9.4 Overview of HART33
 - 5.9.5 Connecting to HART33
 - 5.10 Connecting the analog modules (optional)34
 - 5.10.1 Overview of 4-way current output34
 - 5.10.2 Connecting the 4-way current output34
 - 5.10.3 Overview of the 4-way current input35
 - 5.10.4 Connecting the 4-way current input35

- 6 Commissioning..... 36
- 7 Operation 37
 - 7.1 Operation basics 37
 - 7.2 Control elements in measuring mode 38
 - 7.3 Menu button 38
 - 7.4 Valu button 38
 - 7.5 Info button 39
 - 7.5.1 Page 1, Info button 39
 - 7.5.2 Page 2, Info button 40
 - 7.6 Diag button 41
 - 7.7 Functions of the log screen (Log button)..... 42
 - 7.8 Displays in measuring mode..... 43
 - 7.9 Lock / unlock the touch screen..... 44
 - 7.10 Switching to service mode 45
 - 7.11 Control components in service mode 46
 - 7.11.1 Input elements in service mode..... 46
 - 7.11.2 Numerical entry 47
 - 7.11.3 Single selection of functions 48
 - 7.11.4 Multiple selection of functions..... 48
- 8 Settings 49
 - 8.1 Setting the operating language..... 49
 - 8.2 Setting the current outputs..... 50
 - 8.3 Setting the limits..... 51
 - 8.3.1 Upper and lower threshold value of a limit 52
 - 8.3.2 Reading if limit exceeded or undershot 52
 - 8.4 Setting the outputs 53
 - 8.5 Activating the optional flow meter..... 54
 - 8.6 Setting the date and time 55
 - 8.7 Setting or changing the access code 56
 - 8.8 Backup configured data..... 57
- 9 Servicing 58
 - 9.1 Servicing schedule 59
 - 9.2 Cleaning the measuring cell 60
 - 9.3 Replacing the desiccant 62
 - 9.4 Recalibrating the photometer 63
 - 9.5 Carrying out the sensor check..... 64
 - 9.6 Replacing the filter cartridge on the filter unit 65
 - 9.7 Changing the battery in the SICON (M) 66
- 10 Troubleshooting 67
 - 10.1 Pinpointing faults..... 67
 - 10.1.1 Warning messages and effect on operation 67
 - 10.1.2 Fault messages and effect on operation..... 69
 - 10.1.3 Prioritized fault messages and their effect on operation..... 71

11	Customer service information	72
12	Decommissioning/Storage	73
12.1	Decommissioning the photometer	73
12.2	Storing the photometer	73
13	Packaging / Transport / Returning	74
14	Disposal	75
15	Spare parts list	76
16	Index	78

1 General user information

1.1 Terms used in this document (glossary)

Please refer to our website for specialist terms: www.photometer.com/en/glossary/

1.2 Purpose of the Instruction Manual

This Instruction Manual provides the user with helpful information about the entire life cycle of the ColorPlus 3 and its peripheral devices. Before commissioning the instrument, you should be completely familiar with the Instruction Manual.

1.3 Target group of the documentation

The Instruction Manual is intended for all persons who are responsible for the operation and maintenance of the instrument.

1.4 Additional documentation

DOC. NO.	TITLE	CONTENT
14535E	Brief Instructions	The most important functions and the servicing schedule.
14534E	Reference Handbook	More sophisticated menu functions and worksteps for advanced users.
14723E	Data Sheet	Description of SAC 254 application in water.
15496E	Data Sheet	Description of nitrate application with in water.
14536E	Service Manual	Repair and conversion instructions for service engineers.
14631DEF	Declaration of Conformity	Compliance with the underlying directives and standards.

1.5 Copyright provisions

This document has been written by SIGRIST-PHOTOMETER AG. Copying or modifying the content or giving this document to third parties is permitted only with the express consent of SIGRIST-PHOTOMETER AG.

1.6 Document storage location

This document is part of the product. It should be stored in a safe place and always be close at hand for the user.

1.7 Order document

The most recent version of this document can be downloaded at www.photometer.com (first time registration required).

It can also be ordered from a SIGRIST representative in your country (→ Instruction Manual "Customer service information").

1.8 Proper use

The ColorPlus 3 and its peripherals are designed for measuring absorption in water.

1.9 User requirements

The instrument may be operated only by trained technical personnel who have read and understood the content of the Instruction Manual.

1.10 Declaration of conformity

Current technological principles were followed in designing and manufacturing the instrument. They comply with the applicable guidelines concerning safety and duty to take due care.



EU: The measuring instrument meets all applicable requirements within the European Union (EU) for carrying the CE mark.



Please refer to the separate declaration of conformity for details. Section 1.4

1.11 Use restrictions



**EXPLOSION
HAZARD!**

Operation in an inappropriate environment.

Use in explosive areas can cause explosions, which can lead to the death of persons in the vicinity.

- It is not permitted to operate the instrument in explosion hazardous areas or rooms.
- It is not permitted to use the instrument with explosive sample substances.

1.12 Dangers when not used properly



DANGER!

Operation when not used properly.

Improper use of the instrument can cause injuries to persons, process-related consequential damage and damage to the instrument and its peripherals.

In the following cases the manufacturer cannot guarantee the protection of persons and the instrument and therefore assumes no legal responsibility:

- The instrument is used in a way not included in the described area of application.
- The instrument is not properly mounted, set up or transported.
- The instrument is not installed and operated in accordance with the Instruction Manual.
- The instrument has been operated with accessory parts which SIGRIST-PHOTOMETER AG has not expressly recommended.
- Improper changes to the instrument have been performed.
- The instrument has not been operated within the specifications, in particular concerning pressure and temperature.
- The instrument is exposed to vibrations, shocks or other mechanical forces.

1.13 Meaning of the safety symbols

All **danger symbols** used in this document are explained below:



DANGER!

Danger due to electrical shock that may result in serious bodily injury or death.

Non-observance of this notice may lead to electrical shocks and death.



**EXPLOSION
HAZARD!**

Danger due to explosion that may result in serious bodily injury or death.

Non-observance of this notice may cause explosions resulting in serious property damage and death.



WARNING!

Warning about bodily injury or hazards to health with long-term effects.

Non-observance of this warning may lead to injuries with possible long-term effects.



CAUTION!

Notice about possible material damage.

Non-observance of this notice may cause material damage to the instrument and its peripherals.

1.14 Meaning of the pictograms

All **pictograms** used in this document are explained below:



Additional information about the current topic.



Practical procedures when working with the ColorPlus 3.



Manipulations on the touchscreen.

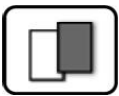

The screenshot is an example and may differ from current device.

2 Instrument overview

2.1 Overview of a measuring point

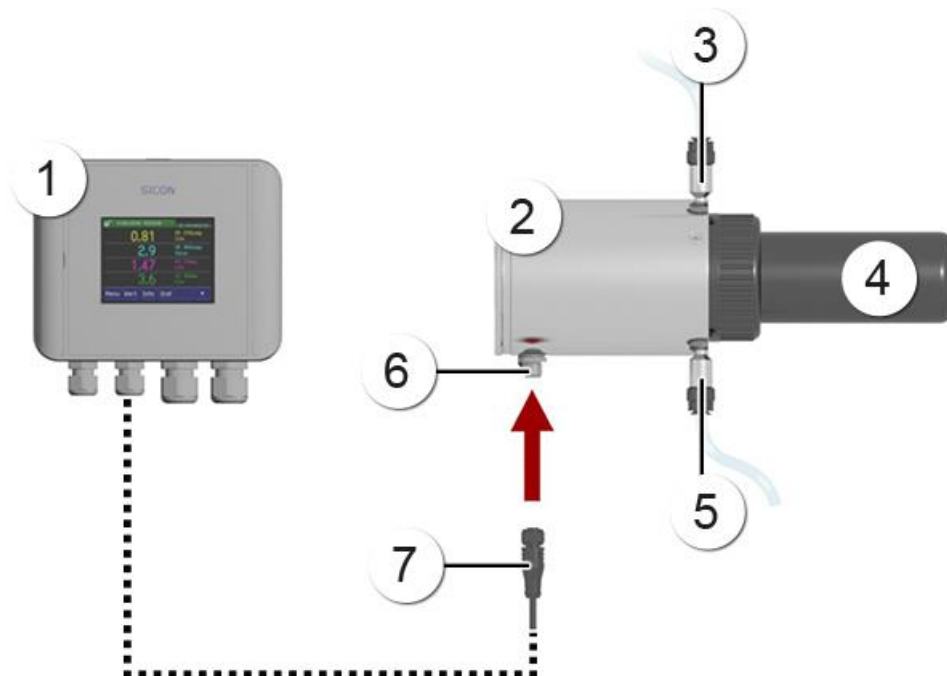

Figure 1: Overview of a measuring point

①	SICON control unit	②	ColorPlus 3
③	Sample outlet	④	Measuring cell (example: 100 mm path length)
⑤	Sample inlet	⑥	Plug connection
⑦	Connector, 4-pin		

2.2 Designation of the ColorPlus 3

The SICON control unit and ColorPlus 3 are each fitted with a rating plate:

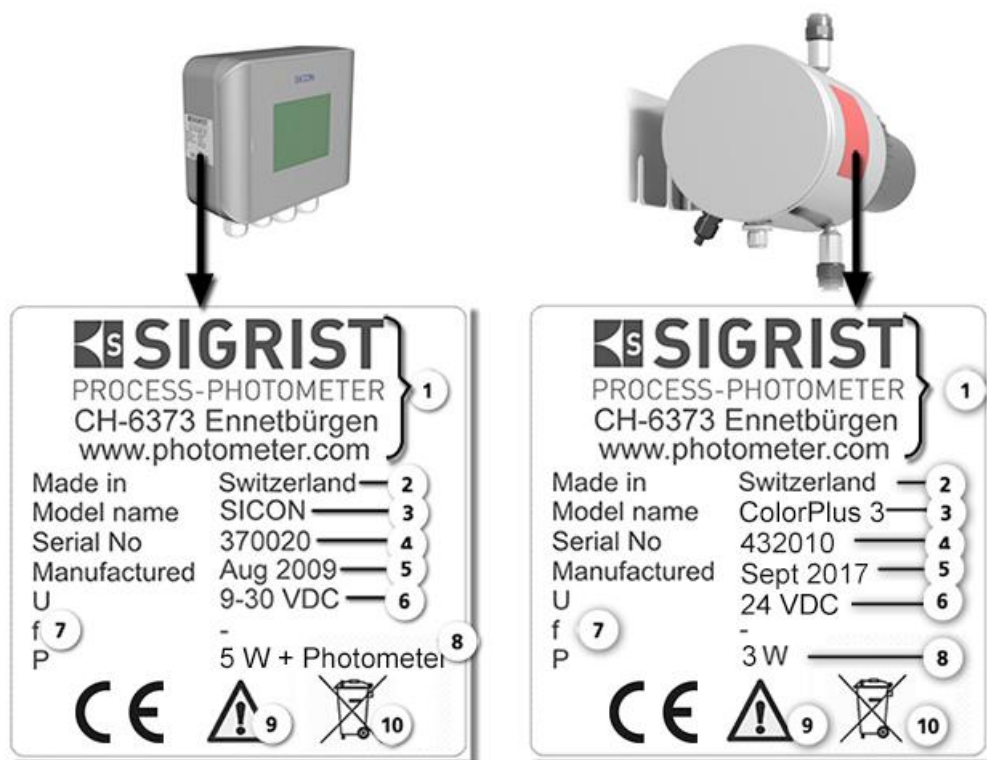





Figure 2: Rating plates on the instruments

①	Manufacturer	②	Country of origin
③	Product name	④	Serial number
⑤	Date of manufacture	⑥	Service voltage
⑦	Frequency range	⑧	Power
⑨	Observe the Instruction Manual	⑩	Observe the disposal information











2.3 Scope of supply and accessories

2.3.1 Standard scope of supply for the ColorPlus 3

PCS.	ART. NO.	NAME	VIEW	VARIANT
1	See the website	ColorPlus 3		UV: <ul style="list-style-type: none"> Layer 100/10 mm Layer 50/10 mm Nitrate: <ul style="list-style-type: none"> Layer 5/1.5 mm
1	118342	SICON control unit		
1	120442	Device cable, 4-pin, 10 m with connector		

PCS.	ART. NO.	NAME	VIEW	VARIANT
1	14501	Instruction Manual		German French English
1	14534	Reference Handbook		German English
1	14535	Brief Instructions		German French English

2.3.2 Optional accessories for the ColorPlus 3

PCS.	ART. NO.	NAME	VIEW	VARIANT
1	118442	Profibus DP inter- faces print		For SICON (M) only
1	118445	Modbus RTU inter- faces print		For SICON (M) only
1	119796	HART module		For SICON (M) only
1	119130	4-way current output		For SICON (M) only
1	119795	4-way current in- put		For SICON (M) only
1	119045	24 VDC mains de- vice 20W, IP66, input 100 to 240 VAC		
1	109534	Connection box		
1	see the website	Set for wall moun- ting, with/ without filter unit and flow rate sensor		Incl. special wrench, art. no.: 121039 
1	190040	SICON M multi- control unit		
1	120538	Device cable, 4- pin, 20 m with connector		
1	120539	Device cable, 4- pin, 30 m with connector		

2.4 Technical data for the ColorPlus 3

Absorbance measurement	Values	
Measuring principle	Absorption	
Measuring scope	UV 100 mm	0 .. 1 to 0 .. 30 E/m
	UV 50 mm	0 .. 2 to 0 .. 60 E/m
	Nitrate 5/1.5 mm	0 .. 100 mg/l NO ₃
	Hazen	Depending on wavelength
Measuring ranges	8, freely configurable	
Wavelength	1 .. 3 different wavelengths 200 – 800 nm Nitrate: 214 nm for nitrate and 254 nm for compensation	
Resolution	UV: 0.001 E Nitrate: 0.01 mg/l	
Reproducibility	UV:	
	Extinction	Tolerance
	0 .. 1 E	± 2 % of meas value, > 0,001 E
	1 .. 2 E	± 3 % of meas value
	2 .. 3 E	± 4 % of meas value
Nitrate: +/- 0.1 mg/l or +/- 1 % from measuring value (whichever is greater)		
Linearity	Better than ± 0.5% transmission	

ColorPlus 3	Values
Analog channels	2 x 0.4 .. 20 mA
Service voltage	24 VDC ± 10 %
Power consumption	3 W (photometer only)
Dimensions	See detailed dimension sheet
Weight	3.4 kg
Protection class	IP 67
Ambient temperature	- 20 .. 50 °C
Ambient humidity	0 .. 100% rel. Humidity
Photometer material	Stainless steel 1.4301

Measuring cell data	Values
Material	PVC housing, stainless steel 1.4435
Window	Quartz glass
Plastic push-in connections	D = 8 mm / G ¼" thread
Max. medium temperature	0 .. 50 °C
Max. medium pressure	600 kPa (6 bar)
Flow rate	0.5 .. 1 l/min

SICON control unit	Values
Service voltage and power consumption	24 VDC ± 10 % 5 W (only SICON)
Display	¼ VGA with touchscreen Resolution: 320 x 240 pixels with 3.5" diagonal
Outputs/inputs	Outputs: <ul style="list-style-type: none"> ▪ 4 x 0/4 .. 20 mA, galvanically isolated up to max. 50 V relative to ground and max. 500 Ω burden. ▪ 7 x digital outputs up to max. 30 VDC, freely configurable, 1 output as de-energized closed relay. Inputs: <ul style="list-style-type: none"> ▪ 5 x digital inputs up to max. 30 VDC, freely configurable.
Interfaces	Ethernet, SD card (for logging, SW update, diagnostics), Modbus TCP, optional: Modbus RTU, Profibus DP, HART, Profinet IO
Protection class	IP66
Weight	Approx. 0.6 kg
Dimensions	160 x 157 x 60 mm
Housing material	ABS

24 VDC mains device	Values
Service voltage	100 .. 240 VAC, 47 .. 63 Hz
Power consumption	Max. 25 W (the power consumption of the connected sensors must not exceed 21 W)
Maximum operating altitude	2,000 m above sea level
Protection class	IP66
Weight	0.66 kg
Dimensions	Approx. 130 x 155 x 55 mm (W x H x D)
Housing material	PC

3 General safety points

3.1 Dangers when properly used



DANGER!

Damaged instrument or cabling.

Touching damaged cables may lead to electrical shocks or death.

- The instrument may be operated only when the cables are undamaged.
- The instrument may be operated only if it has been properly installed or repaired.



DANGER!

Dangerous voltage inside the instrument.

Touching live components inside the instrument may lead to electric shocks resulting in death.

- The instrument must not be operated when the housing is removed or opened.



DANGER!

Damage to the instrument due to incorrect service voltage.

If the instrument is connected to an incorrect service voltage, the instrument can be damaged.

- The instrument may be connected only to voltage sources as specified on the rating plate.



DANGER!

Missing Instruction Manual after the instrument changes hands.

Operating the instrument without knowledge of the Instruction Manual may lead to injuries to persons and damage to the instrument.

- If the instrument changes hands, always include the Instruction Manual.
- If the Instruction Manual is lost, you can request a replacement.
Registered users can download the current version at www.photometer.com.



CAUTION!

Escaping medium from leaks on the instrument or water connections.

Escaping medium can lead to flooding of the room and material damage to the building and fittings.

- Check that there are no leaks.



DANGER!

Manipulations on pressurized lines.

Improper manipulations on a pressurized line can lead to the sample escaping under pressure, resulting in injuries, damage to the instrument and material damage on site.

- Always consult the Instruction Manual before making any manipulations to pressurized lines.
- The medium line must be emptied before removing the instrument or opening the measuring cell.

**CAUTION!****Eye injuries caused by UV radiation.**

During operation, there is dangerous UV radiation that can cause eye damage.

- Always interrupt the service voltage before opening the instrument.
- Never look directly into the light beam.
- Do not use any reflective objects when cleaning the measuring cell.

**CAUTION!****Penetration of moisture as well as condensation on the electrical components during servicing duty.**

If moisture enters the instrument, the ColorPlus 3 can be damaged.

- Work inside the instrument may be performed only in a dry room and at room temperature. The instrument should be at operating or room temperature (avoid condensation on optical and electrical surfaces).

**CAUTION!****The use of aggressive chemicals when cleaning.**

Use of aggressive chemicals can cause damage to instrument components.

- Do not use aggressive chemicals or cleaning agents when cleaning.
- Should the instrument come in contact with aggressive chemicals, clean it thoroughly with a neutral cleaning agent.

3.2 Residual risk

**WARNING!**

According to the risk assessment of the applied safety directive DIN EN 61010-1, there remains the risk of the displayed measuring values being incorrect. This risk can be reduced with the following measures:

- Use an access code to prevent unauthorized persons from changing parameters.
- Perform the specified servicing duties.

3.3 Warning and danger symbols on the instrument

**WARNING!****There are no warning or danger symbols on the instrument.**

Users must ensure that they observe the safety measures as specified in the Instruction Manual at all times when working with the instrument and its peripheral equipment, even if no warning or danger symbols are attached to the instrument.

The following sections must be internalized:

- Section 1.11
- Section 1.12
- Section 1.13
- Section 3.1
- Section 3.2
- Observe safety pointers when performing the described procedures.
- Observe local safety pointers.

3.4 Preventing undesirable online access attempts

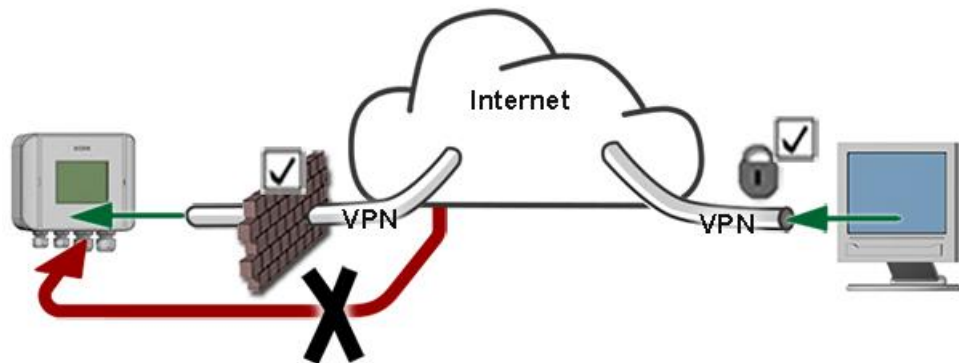

WARNING!

SIGRIST instruments are equipped with an integrated web user interface and Modbus TCP interface, thus offering state-of-the-art administration and control possibilities. However, if these are connected directly to the Internet, then any Internet user can in principle access your instrument and change the configuration.

Please note the following points to prevent this:

- Never connect the instrument directly to the Internet.
- Operate it behind a firewall and block access to the instrument.
- Only connect to branch offices via VPN.
- Change the standard password on commissioning.
- Always keep up to date with the latest changes regarding Internet security so that you can react promptly in the event of alterations.
- Install the latest updates immediately (also for the router and firewall).

4 Mounting

4.1 Mounting the ColorPlus 3

Note the following points when mounting the instrument:

- The ColorPlus 3 must be installed horizontally. The sample outlet (Y) must be positioned at the top so that the measuring cell can be well ventilated.
- A regulator valve must be installed on the sample outlet (Y) so that counter pressure can be generated (operation of the measuring cell under pressure so that disruptive air bubbles are eliminated).

Mount the ColorPlus 3 as follows:



	WORKSTEP	ADDITIONAL INFO / IMAGES
1.	Install the ColorPlus 3 horizontally onto a wall using two M6 screws on the fastening plate.	
2.	Connect the hoses (D = 8 mm) to the sample inlet and outlet. X: Sample inlet Y: Sample outlet  The G 1/4" threads can be accessed by removing the push-in connections (X, Y).	

4.2 Mounting the SICON (M)



	WORKSTEP	ADDITIONAL INFO / IMAGES
1.	Open the shutters.	
2.	Fasten the control unit to the wall using four screws (circles).	

5 Electrical installation

5.1 Safety pointers for the electrical connection



DANGER!

Connecting the service voltage.

Improper connection of the service voltage can be potentially fatal. The system may also be damaged. Local regulations for electrical connection must be observed at all times.

Further, the following basic principles must be observed:

- Because the system has no main switch, a suitable disconnection device (switch, plug) should be installed near the service voltage. It must be designated and easily accessible.
- It is imperative that the protective conductor is connected.
- The system must not be charged with voltage until the installation is completed and all covers are mounted.
- On systems with a service voltage of between 100 and 240 VAC, a back up fuse with a max. tripping current of 16 A must be present. The cables must be able to withstand this load.
- If faults cannot be remedied, the system must be put out of operation and protected against inadvertent operation.

5.2 Opening the cover on the SICON (M)



	WORKSTEP	ADDITIONAL INFO / IMAGES
1.	Open the shutters.	
2.	Loosen the fastening screws on the cover.	
3.	Open the cover.	
4.	Fasten the cover with the cover clamp. To do this, remove the cover clamp from the park position (X) and fasten the cover in position (Y).	

5.3 Overview of the opened SICON (M) control unit

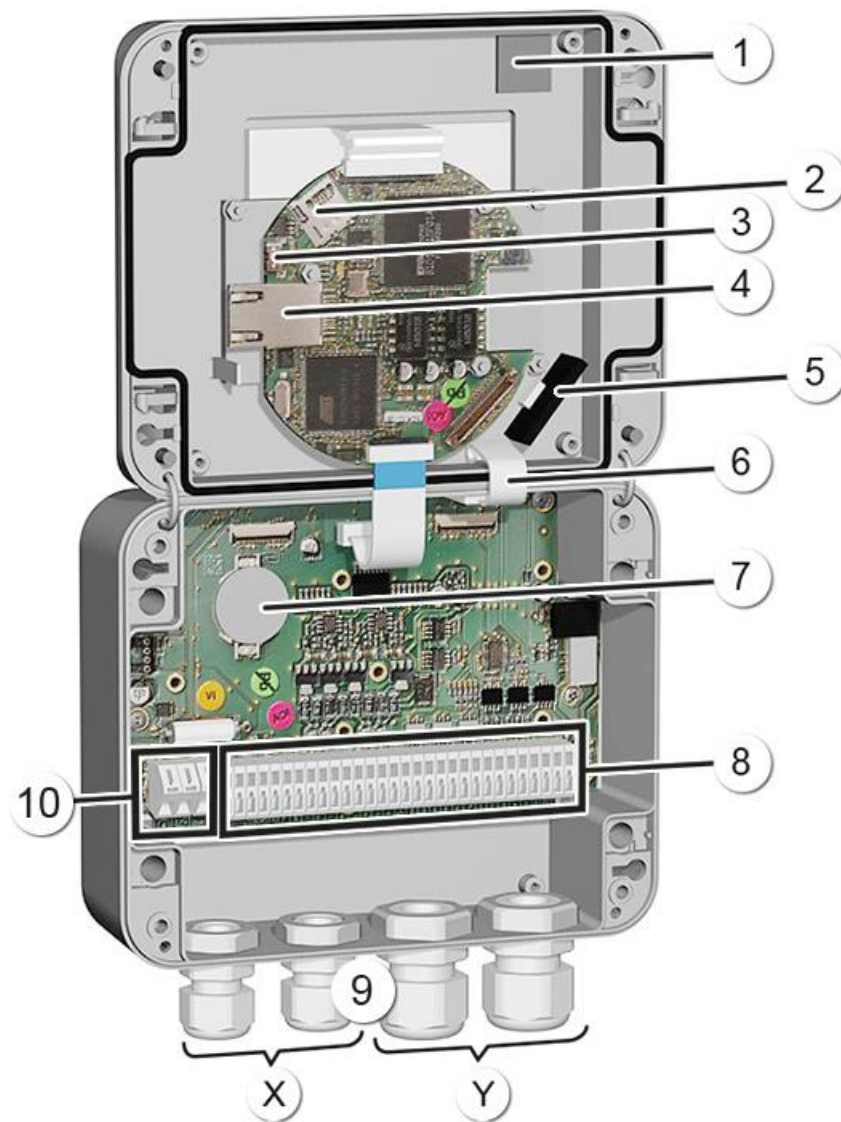

Figure 3: Overview of SICON (M)

①	Park position for cover clamp	②	microSD card (card for log data)
③	USB connection	④	Ethernet connection
⑤	SD card adapter with holder	⑥	Cover clamp in holding position
⑦	Battery	⑧	External connections
⑨	Cable glands X: 4 .. 8 mm Y: 8 .. 13 mm	⑩	Connections for the service voltage 24 VDC ± 10 %

5.4 Connecting the SICON (M)



DANGER!

Life-threatening voltage inside the instrument.

Connecting electrical lines can be extremely dangerous. Instrument parts may also be damaged. Local regulations for electrical installations must be observed at all times.



Figure 4: SICON Standard terminal block

Establish the electrical connections in the following sequence:

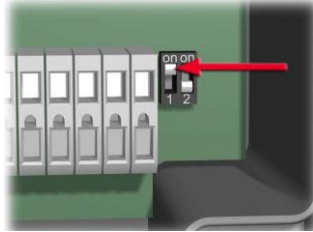

	TERMINAL	MEANING	REMARKS
1.	8 .. 11	Connection to the photometer	Terminal 8: GND (Ground) => Cable color: White
			Terminal 9: 24 V => Cable color: Brown
			Terminal 10: A => Cable color: Blue
			Terminal 11: B => Cable color: Black
2.	4 .. 7	Connection of the external expansion module (optional)	
3.	12 .. 19	Curr. outputs 1 .. 4	Maximum loop resistance 500 Ohm.
4.	21 .. 27	Digital optocoupler outputs	Terminal 21 is closed de-energized Terminals 22 .. 27 are open de-energized
5.	28 .. 32	Digital inputs	
6.	33 .. 34	Internal power supply for operating signals	DIL switch (1) must be ON. → Reference Manual 
7.	1 .. 3	Service voltage	24 VDC ± 10 %



The use of operating signals is described in the Reference Manual.

5.5 Connecting the instrument cable to the ColorPlus 3

A 4-pin connector of type M12 x 1 with A-coding is used. The connector assignment is as follows:

Description	Connector pin (male)	Wire color for device cable (SIGRIST cable)	Remarks
			
Supply GND	2	White	
24 VDC power supply	1	Brown	
RS 485 A	3	Blue	Serial interface
RS 485 B	4	Black	

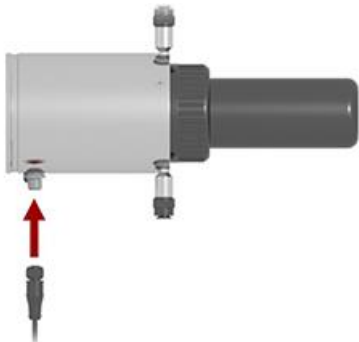

WORKSTEP	ADDITIONAL INFO / IMAGES
Insert the connector on the photometer.	

5.5.1 Cable cross-sections over longer distances

- For connections longer than the standard cable length, an optional connection box must be connected between the photometer and control unit.
- The maximum distance between the control unit and photometer depends on the cable cross-section used and the available power supply (see table below).
- Shielded cables should be used.

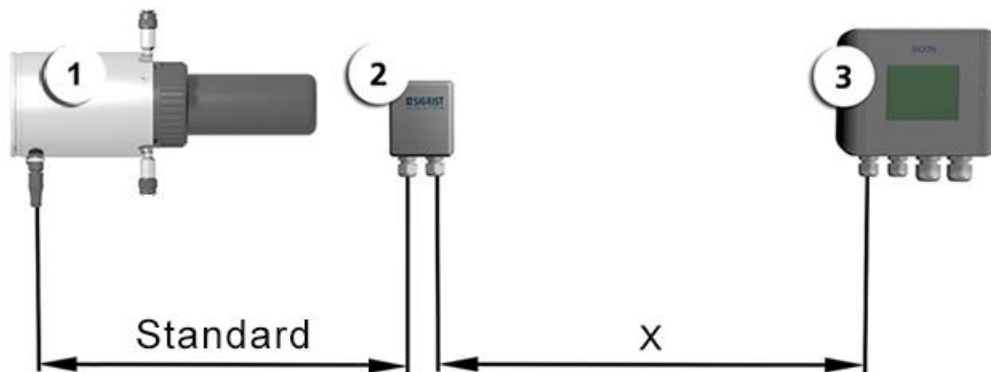

Figure 5: Arrangement of control unit over longer distances

①	Photometer	②	Connection box
③	Control unit		

The maximum distance (X) between the control unit and connection box depends on the voltage in the SICON and the cable cross-section used:

Cable cross-section	Max. distance	Remarks
[mm ²]	[m]	
0.14	50	
0.25	90	
0.34	120	Standard version
0.50	180	
0.75	270	
1.00	350	
1.50	500	

5.6 Connecting the connection box

The terminals in the connection box are assigned as follows:

CONNECTION FOR PHOTOMETER		CONNECTION FOR CONTROL UNIT	
Terminal	Cable	Terminal	Function
Blue	White	Blue	GND
Orange	Brown	Orange	24 V
Dark gray	Blue	Dark gray	A
Light gray	Black	Light gray	B



The cable shields must be connected to each other.

5.7 Connecting the optional flow meter

The following procedure describes how to install the flow meter on the ColorPlus 3:

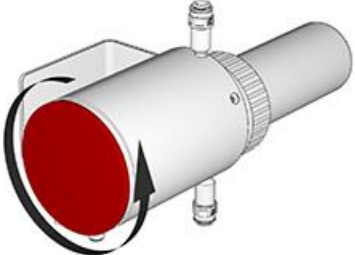
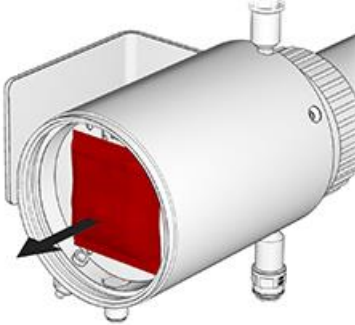
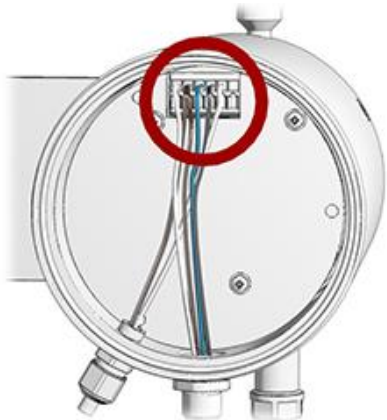
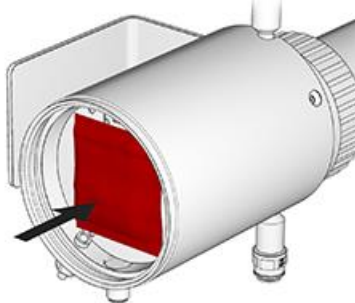

	WORKSTEP	ADDITIONAL INFO / IMAGES																								
1.	Interrupt the service voltage to the photometer.																									
2.	Unscrew the cover on the ColorPlus 3.																									
3.	Remove the desiccant.																									
4.	<p>Attach the cable connections according to the following table.</p> <p>From M12 plug (already present):</p> <table border="1" data-bbox="453 1249 992 1350"> <tr> <td>GND</td> <td>24V</td> <td>A</td> <td>B</td> <td>In 1</td> <td>In 2</td> </tr> <tr> <td>White</td> <td>Brown</td> <td>Blue</td> <td>Black</td> <td></td> <td></td> </tr> </table> <p>Optional flow meter:</p> <table border="1" data-bbox="453 1440 992 1541"> <tr> <td>GND</td> <td>24V</td> <td>A</td> <td>B</td> <td>In 1</td> <td>In 2</td> </tr> <tr> <td></td> <td>Brown</td> <td></td> <td></td> <td>White</td> <td></td> </tr> </table>	GND	24V	A	B	In 1	In 2	White	Brown	Blue	Black			GND	24V	A	B	In 1	In 2		Brown			White		
GND	24V	A	B	In 1	In 2																					
White	Brown	Blue	Black																							
GND	24V	A	B	In 1	In 2																					
	Brown			White																						
5.	<p>Insert the new desiccant and screw the cover back onto the ColorPlus 3 immediately.</p> <hr/> <p>i Check the gasket on the cover (88 x 2). Replace this, if necessary.</p> <hr/>																									

5.8 Connecting the optional 24 VDC power supply



DANGER!

Life-threatening voltage due to accidentally released voltage-carrying wires.

- The wires of the supply connection must be secured with cable ties so that if one wire accidentally becomes loose no other parts can be charged with voltage.
- Cable with an outer diameter of 4 to 8 mm must be used.

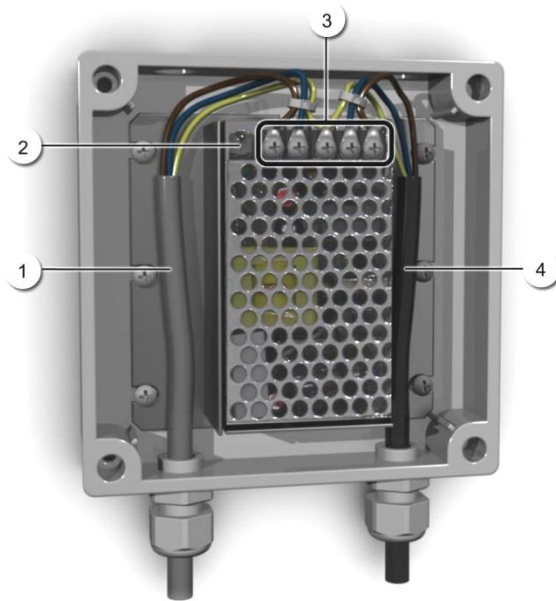

Figure 6: Optional power supply with removed cover

①	Cable to SICON (24 VDC)	②	Indicator lamp
③	Screw terminals	④	Cable from mains (100-240 VAC)

The terminals are assigned as follows for connecting the mains device:

Terminal designation in the power supply	Cable color	Terminal designation in the SICON	Function
+24 V	Brown	2: 9 V to 30 V	24 VDC
RTN	Blue	3: GND	Ground
Protective ground	Yellow-green	1: Ground connection	Ground connection
Protective ground			Mains protective ground
N			Mains neutral conductor
L			Mains live

5.9 Connecting the field bus interfaces (optional)



Information on commissioning the field bus interfaces can be found in the Reference Handbook.

5.9.1 Overview of Profibus DP and Modbus RTU

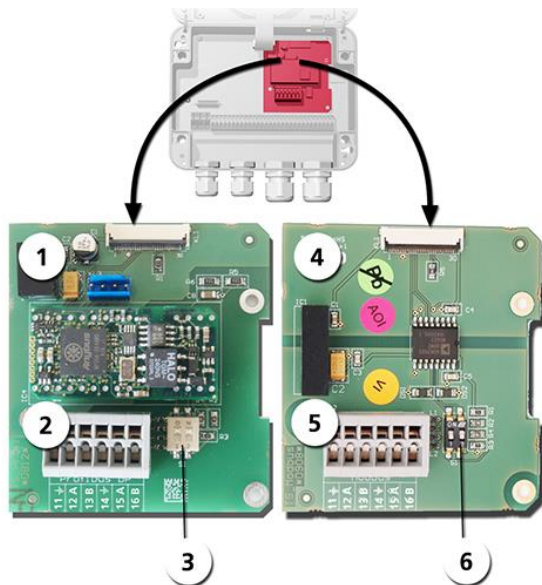

Figure 7: Overview of the Profibus DP and Modbus RTU modules

①	Field bus interface (connection printed circuit board) for Profibus DP .	④	Field bus interface (connection printed circuit board) for Modbus RTU .
②	Profibus DP terminals.	⑤	Modbus RTU terminals.
③	DIL switch for matching resistors. Switches (1 and 2) must be ON .	⑥	DIL switch for matching resistors. Switches (1 and 2) must be ON .

5.9.2 Connecting the Profibus DP or Modbus RTU

The terminals on the Profibus DP or Modbus RTU module are assigned as follows:

TERMINALS	PROFIBUS/ MODBUS	FUNCTIONAL DESCRIPTION
11 \equiv	Ground IN	Connection for cable shielding
12 A	RS 485-A IN	Data connection
13 B	RS 485-B IN	Data connection
14 \equiv	Ground OUT	Connection for cable shielding
15 A	RS 485-A OUT	Data connection
16 B	RS 485-B OUT	Data connection

5.9.3 Overview of Profinet IO

- To connect to the Profinet IO, the Profinet IO module must be integrated in the SICON (M).
- The module has an internal switch and provides two Ethernet ports.
- The cable is connected directly to the RJ45 plug of the Profinet IO module inside the instrument or via external M12 connectors.

⚠ When connecting directly to the RJ45 plug, please note that only plugs with a short and flat design can be used.

- In the **Digi.interf. \ General** menu, the **Modul type** must be set to **Profinet IO**.
- In the **Digi.interf. \ Profinet** menu, the station name, MAC address and connection status are shown. Moreover, it can be defined here whether the data should only be read or be read and written.

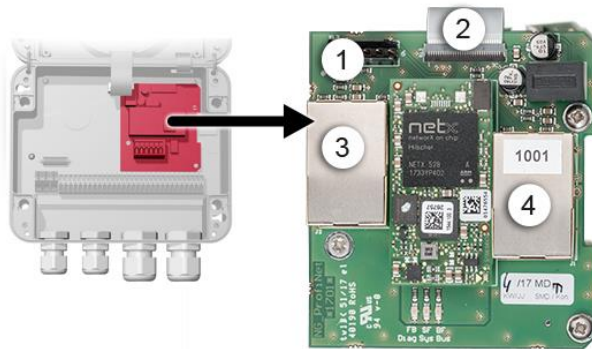

Figure 8: Overview of the Profinet IO module

①	Field bus interface (connection print) for Profinet IO	②	Connector for SICON (M)
③	Ethernet port 1 (can be used as in- or output)	④	Ethernet port 2 (can be used as in- or output)

5.9.4 Overview of HART



Information on commissioning the field bus interfaces can be found in the Reference Handbook.

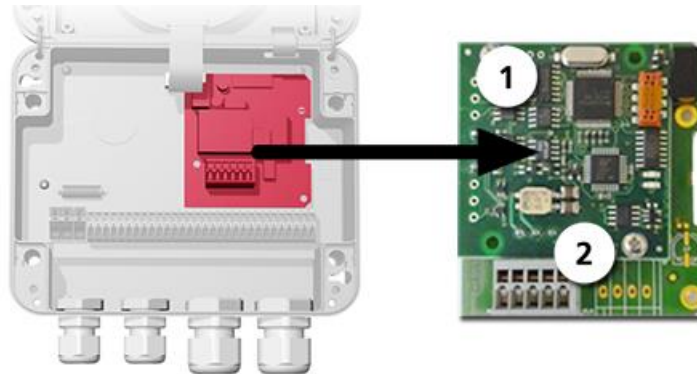

Figure9: Overview of the HART module

①	Field bus interface (connection print) for HART. Serves as interface to HART.	②	HART terminals
---	---	---	----------------

5.9.5 Connecting to HART

The terminals of the HART module are configured as follows:

Terminals	HART	Functional description
1	mA+ In	Must be connected with terminal 13 (mA 1+) of SICON (M).
2	mA- In	Must be connected with terminal 12 (mA 1-) of SICON (M).
3	Shield	Cable shielding.
4	mA+ Out	Current output 1 (+) with HART.
5	mA- Out	Current output 1 (-) with HART.

The loop resistance on current output 1 can be between 230 and 500 Ohm for HART communication.

5.10 Connecting the analog modules (optional)

5.10.1 Overview of 4-way current output

The configuration of the current outputs is described in the Section 8.2.

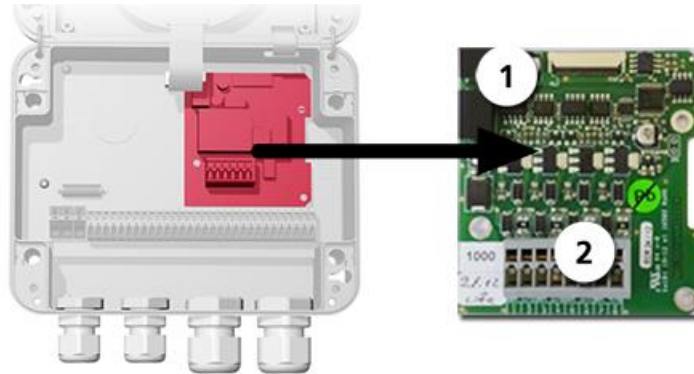

Figure 10: Overview of the 4-way current output module

①	4-way current output	②	Terminals
---	----------------------	---	-----------

5.10.2 Connecting the 4-way current output

The terminals of the 4-way current output are configured as follows:

Terminals	4-way current output	Functional description
1	mA 5 -	Current output 5
2	mA 5 +	
3	mA 6 -	Current output 6
4	mA 6 +	
5	mA 7 -	Current output 7
6	mA 7 +	
7	mA 8 -	Current output 8
8	mA 8 +	

The burden on the current outputs can be a maximum of 500 Ohm.

5.10.3 Overview of the 4-way current input

The configuration of the current inputs is described in the Reference Handbook.

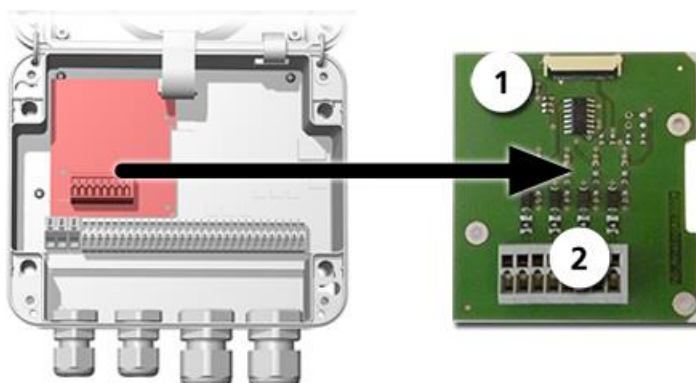

Figure 11: Overview of the 4-way current input module

①	4-way current input	②	Terminals
---	---------------------	---	-----------

5.10.4 Connecting the 4-way current input

The terminals of the 4-way current input are configured as follows:

Terminals	4-way current input	Functional description
1	In 1 -	Current input 1
2	In 1 +	
3	In 2 -	Current input 2
4	In 2 +	
5	In 3 -	Current input 3
6	In 3 +	
7	In 4 -	Current input 4
8	In 4 +	

Current inputs 1 .. 4 are intended for connecting external 0/4 .. 20 mA signals. The inputs are not galvanically isolated and the negative inputs are connected to the ground of the instrument. The input resistance is 100 Ohm.

6 Commissioning



The initial start-up of the web user interface via the Ethernet interface is described in the Reference Manual. If malfunctions occur, consult the Section 10.

Proceed with the initial start-up in accordance with the following table:



	WORKSTEP	ADDITIONAL INFO / IMAGES
1.	Ensure that the photometer and control unit are correctly mounted and connected.	Section 4 and Section 5
2.	Establish the service voltage to the SICON. The welcome screen appears on the display. i The factory setting language is English.	
	2.2: The instrument carries out an internal functional check.	
	2.3: The instrument is ready for measurement.	
3.	Set the language.	Section 8.1
4.	Set the current outputs.	Section 8.2
5.	Set the limits.	Section 8.3
6.	Set the outputs.	Section 8.4
7.	Activate the optional flow meter.	Section 8.5
8.	Set the date and time.	Section 8.6
9.	Enter the access code.	Section 8.7
10.	Carry out recalibration.	Section 9.4
11.	Back up the configured data.	Section 8.8

7 Operation

7.1 Operation basics

In this document we describe the practical examples only for the first steps of the menu configuration. All other setting options are described in the Reference Handbook. Operation using the web user interface is described in detail in the Reference Handbook.



The instrument has a touchscreen. It is operated by touching with your finger. The navigation elements change color when touched.



CAUTION!

Sensitive touchscreen.

The touch screen can be damaged through improper handling. Damage can be avoided with the following measures:

- Touch the touchscreen only with your fingers and not with sharp objects.
- Use only slight pressure to perform manipulations on the touchscreen.
- Do not use chemicals or solvents to clean the touchscreen.

7.2 Control elements in measuring mode



Figure 12: Control elements in measuring mode

①	Menu button Calls up the menu structure. Section 7.3	②	Valu button Numerical representation of the measuring values. Section 7.4
③	Info button Displays the information screen. Section 7.5	④	Diag button Graphical representation of the measuring values. Section 7.6
⑤	Up arrow Goes to the previous page.	⑥	Down arrow Goes to the next page.

7.3 Menu button

Pressing the **Menu** button and entering the access code takes you to the menu structure. Now the instrument is in service mode. Operator prompting in service mode is described in Section 7.11.

7.4 Valu button

Pressing the **Valu** button displays the measuring values in numerical form. This is described in detail in Section 7.8.

7.5 Info button

When you press the **Info** button, a general overview of the instrument settings appears.

7.5.1 Page 1, Info button



Figure 13: Info button, screen 1

①	Information about the available current outputs X: Source of the current output Y: Measuring range of the current output	②	Status of the inputs → Reference Manual
③	Status of the outputs → Reference Manual	④	Temperature of the electronics
⑤	Humidity in transmitter housing	⑥	Main menu buttons

7.5.2 Page 2, Info button

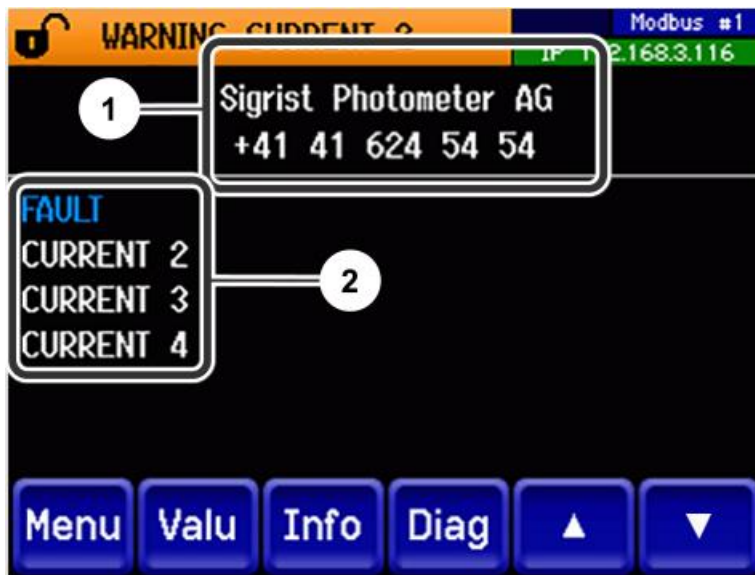

Figure 14: Info screen, page 2

①	Contact information	②	Display of up to 5 pending fault messages
---	---------------------	---	---

7.6 Diag button

When you press the **Diag** button, a diagram appears which graphically shows the measuring values over a certain period of time.

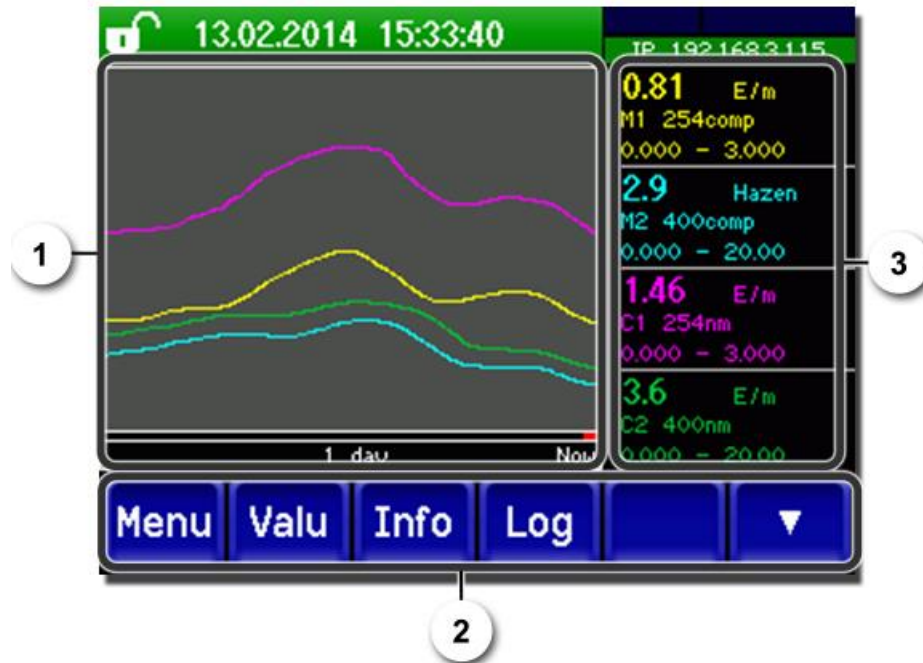

Figure 15: Graphic representation of the measuring values

<p>① Graphic representation of the measuring values The measuring values can be recorded from 3 minutes to 32 days and are graphically represented. The color of the measuring value curves corresponds to the measuring channels on the right side of the display (position 3).</p>	<p>② Main menu buttons 1 The logger functions (Log button) are described in Section 7.7.</p>
<p>③ Measuring channels: Numerical representation of the set measuring channels.</p> <ul style="list-style-type: none"> ▪ Current measuring value ▪ Measuring channel with name ▪ Scaling of the Y-ax 	

7.7 Functions of the log screen (Log button)



The screen logger works independently of the data logger, which is set in the **Logger** menu and writes to the microSD card.

The screen logger records the data of the last 32 days in one-minute intervals. The data can be called up from the Log menu.

If the instrument is out of operation for more than 32 days, the logger data is reinitialised. An hourglass is shown for about 1.5 minutes in the graphic display. During this time, no logger data is available.

The **Log** button is found only in the main menu in the graphic screen; in the **Valu** screen, the **Diag** button has to be pressed first. When the **Log** button is pressed, the following screen appears:



Figure 16: Functions of the Log display

<p>① The cursor shows the time position which is represented at pos. 4. The cursor position can be changed either by briefly touching with your fingertip or by pressing the </> buttons.</p>	<p>② Represented time period The following time ranges can be set: 3 min./15 min./1 hour/ 3 hours/9 hours/1 day/3 days/10 days/ 32 days</p>
<p>③ The red bar indicates how much of the total time period is currently represented.</p>	<p>④ Measuring value which was measured at the cursor position.</p>
<p>⑤ </>: Moves the cursor position. The cursor moves faster when these buttons are held down longer. <</>>: Jumps forward or backward by the time period set in point 2. -/+ : Increases (+) or decreases (-) the screen section around the cursor position.</p>	



In the **Display/General** menu, you can define whether minimum, maximum or mean values are to be displayed. → Reference Handbook
Pressing the **Diag** button takes you to the graphical representation.

7.8 Displays in measuring mode











Figure 17: Displays in measuring mode

<p>①</p>	<p>Measuring value(s) For values which are greater than the maximum measuring range, no measuring value is displayed; instead **** is displayed.</p>	<p>②</p>	<p>Status line In measuring mode, the status line is green and shows the date and time. i If faults should occur, warning and fault messages are shown here and the status line changes to orange or red.</p>								
<p>③</p>	<p>Interface information</p> <ul style="list-style-type: none"> ▪ Top left: Logger status ▪ Top right: Modbus, HART, Profinet or Profibus status ▪ Below: Ethernet IP status The following messages are possible: <ul style="list-style-type: none"> - IP not connected (cable not connected) - IP DHCP running... - IP 169.254.1.1 (example address) <p>Color coding:</p> <table border="1" data-bbox="475 1691 882 1921"> <tr> <td>Black</td> <td>Not active / not present</td> </tr> <tr> <td>Blue</td> <td>Activated, in quiescent mode</td> </tr> <tr> <td>Green</td> <td>Active</td> </tr> <tr> <td>Red</td> <td>Fault</td> </tr> </table>	Black	Not active / not present	Blue	Activated, in quiescent mode	Green	Active	Red	Fault	<p>④</p>	<p>Channel name with unit i The channel names shown in the figure are examples and can be adjusted individually.</p>
Black	Not active / not present										
Blue	Activated, in quiescent mode										
Green	Active										
Red	Fault										

7.9 Lock / unlock the touch screen



MANIPULATION						
1.	Press the lock icon top left.					
2.	<p>Within one second press the key bottom at the outside right.</p> <p>Depending on the initial state, the lock icon changes as follows:</p> <table border="1" data-bbox="451 835 991 981"> <tr> <td></td> <td>Touch screen unlocked</td> </tr> <tr> <td></td> <td>Touch screen locked</td> </tr> </table>		Touch screen unlocked		Touch screen locked	
	Touch screen unlocked					
	Touch screen locked					

7.10 Switching to service mode

The system is configured in service mode. The measuring procedure is interrupted and the main menus appear on the display. Service mode is accessed as follows:



	MANIPULATION	ADDITIONAL INFO / IMAGES
1.	Press the Menu button.	
2.	Enter the access code and confirm with OK .	 Factory setting is 0 .
3.	The main menus appear.	The instrument is now in service mode.

The following applies in service mode:

- * The measuring values remain on the last values on the digital interfaces.
- * Depending on the configuration, the current outputs go to 0/4 mA or remain on the last measuring values.
- The limits are deactivated.
- If an output for service is programmed, it is activated.
- Fault messages are suppressed.

* This does not apply when the **Current outputs\General\For service** parameter is set to **Measure**.



For measuring mode, press the **Meas** button. When switching from service mode to measuring mode, an hourglass appears in the information bar for about 10 seconds. The measuring values are frozen during this time.

7.11 Control components in service mode

7.11.1 Input elements in service mode

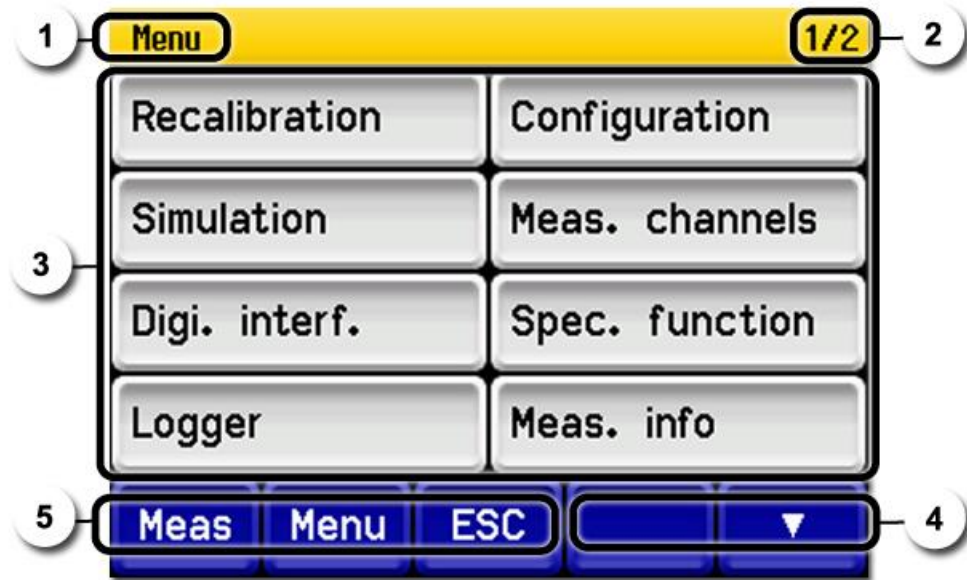
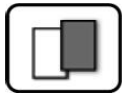

Figure 18: Input elements in service mode

①	Path specification	②	Page number / total number of pages
③	Main menus Instrument-specific menus of the photometer.	④	Next page
⑤	Meas button: The instrument changes to measuring mode. Menu button: The display goes back to main menus and remains in service mode. ESC button: The display goes back one level in the menu hierarchy until the measuring mode finally is reached.		

7.11.2 Numerical entry

The following screen is for entering numbers and data:

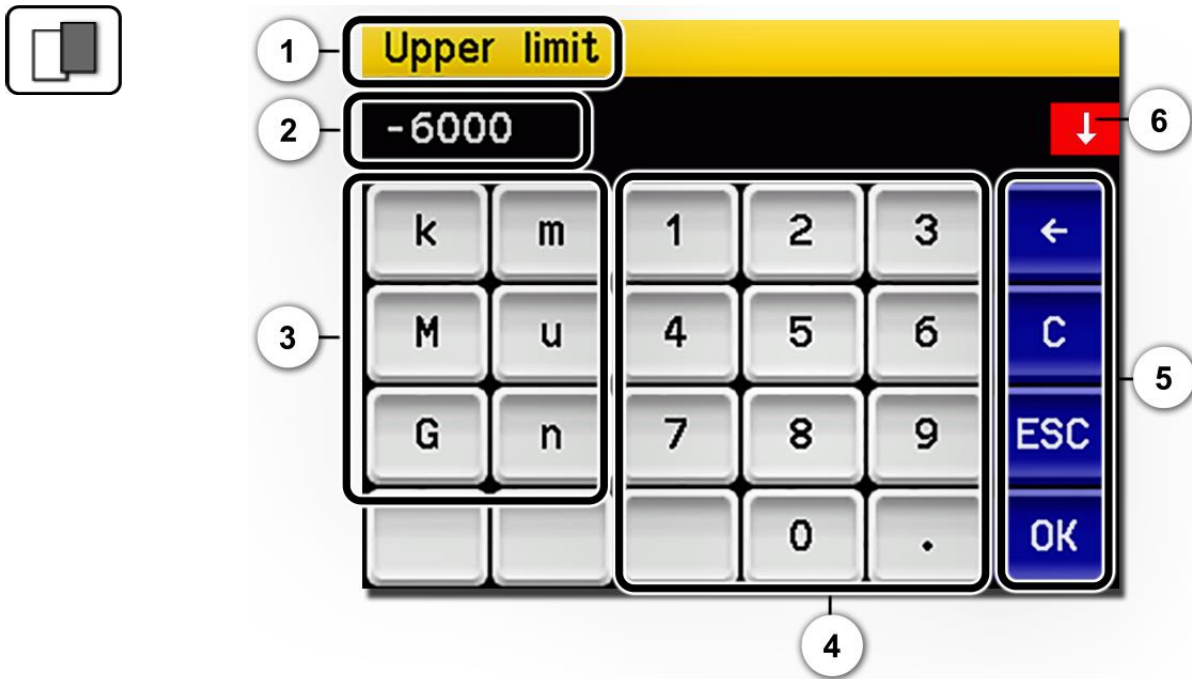

Figure 19: Numerical entry

①	Parameter name	②	Entered values
③	Prefix: For entering very large or very small values. This can be done as follows: 1. Enter value 2. Select SI prefix Function: $n = 10^{-9}$, $u = 10^{-6}$, $m = 10^{-3}$, $k = 10^3$, $M = 10^6$, $G = 10^9$	④	Numerical entry
⑤	\leftarrow : Deletes one digit of the displayed value. C : Clears the displayed value. ESC : Touching the ESC field causes the display to go back one level in the menu hierarchy. The entered value is not saved. OK : Confirm entered value.	⑥	If the value entry is too high or too low, a white arrow appears in a red field top right. Arrow points upward: Entry too high Arrow points downward: Entry too low

7.11.3 Single selection of functions



The single selection is identifiable by the **ESC** button in the lower right corner.

The currently selected function is green. Use the Up/Down arrows to navigate the options in long lists. Use the **ESC** button to cancel the entry. Pressing a selection item saves the configuration and completes the entry.



Figure 20: Example of single selection

7.11.4 Multiple selection of functions

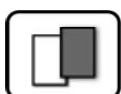

The multiple selection is identifiable by the **OK** button in the lower right corner.

The currently selected values are green. Use the Up/Down arrows to navigate the options in long lists. Pressing a selection item changes the active status of the corresponding item. Press the **OK** button to save the configuration and complete the entry.



Figure 21: Example of multiple selection

8 Settings

8.1 Setting the operating language



	MANIPULATION	ADDITIONAL INFO / IMAGES
1.	Press the Menu button.	
2.	Enter the access code and confirm with OK .	i Factory setting is 0 .
3.	Press the Configuration button to access language selection.	i If the desired menu does not appear, press the arrow bottom right.
4.	Press language field (circle). The list of all languages appears (factory setting is English).	
5.	Apply the desired language by pressing the corresponding field, or press the ESC button to cancel.	
6.	Press the Meas button.	The instrument is in measuring mode again.

8.2 Setting the current outputs



	MANIPULATION	ADDITIONAL INFO / IMAGES
1.	Press the Menu button.	
2.	Enter the access code and confirm with OK .	i Factory setting is 0 .
3.	Press the Curr. outputs button.	i If the desired menu does not appear, press the arrow at the bottom right.
4.	Select between C1 .. 4 .	
5.	Select the source.	The following selection is available: <ul style="list-style-type: none"> ▪ C1 .. n (measuring channels) ▪ M1 .. 3 (math channels) ▪ A1 .. 2 (analog channels) ▪ Humidity
6.	Select the Range .	MR1 .. MR8 In 1, In 2, Auto 1, Auto 2 → Reference Handbook
7.	Press the Meas button.	The instrument is in measuring mode again.

Eight measuring ranges are pre-programmed in the instrument according to the parameter list. If other measuring ranges are required, these can be reprogrammed according to the parameter list or your own requirements. → Reference Handbook

8.3 Setting the limits

The limits have to be configured accordingly so that they are not only displayed, but that the outputs are also switched. Section 8.4



	MANIPULATION	ADDITIONAL INFO / IMAGES
1.	Press the Menu button.	
2.	Enter the access code and confirm with OK .	i Factory setting is 0 .
3.	Press the Limits button.	i If the desired menu does not appear, press the arrow at the bottom right.
4.	Select between L1 .. n .	
5.	Select the source.	The following selection is available: <ul style="list-style-type: none"> ▪ C1 .. n (measuring channels) ▪ M1 .. 3 (math channels) ▪ A1 .. 2 (analog channels) ▪ Humidity
6.	Define the Mode .	The following selection is available: <ul style="list-style-type: none"> ▪ Inactive (limit monitoring of this channel is deactivated) ▪ Exceeded (limit active when the set threshold value is exceeded) ▪ Undershot. (limit active when the set threshold value is undershot)
7.	Define the upper limit, lower limit, cut-in delay and cut-out delay with the number pad.	i Pressing the current number value takes you to the entry mode.
8.	Press the Meas button.	The instrument is in measuring mode again.

8.3.1 Upper and lower threshold value of a limit

A maximum of eight limits with upper and lower threshold can be programmed.

If the operating mode is set to **Exceeded** (Figure 22), then while the upper threshold is exceeded the limit is active and remains active until the lower threshold is again under-shot.

If the operating mode is set to **Undershot**, then while the lower threshold is undershot the limit is active and remains active until the upper threshold is again exceeded.

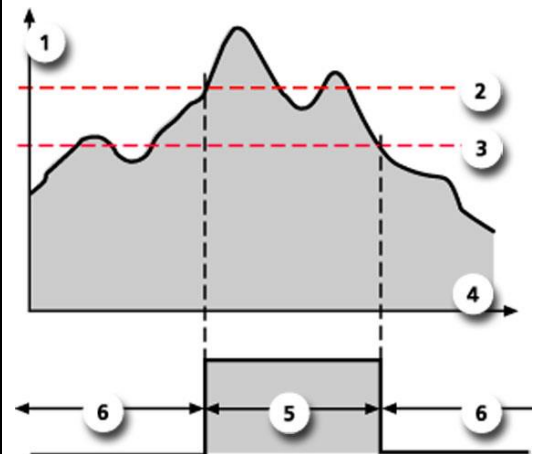

Figure 22: Threshold diagram

①	Measuring value	②	Upper threshold
③	Lower threshold	④	Time
⑤	Limit active	⑥	Limit passive

8.3.2 Reading if limit exceeded or undershot



If a limit event occurs during operation, it has the following effects on measuring mode:

- Threshold value display indicates an unusual state.
- If an output for the corresponding limit channel is programmed, it is switched.

If the message **Limit** appears, the color of the status display changes to **white** and the numbers of the limit channels are listed with their channel numbers in **red** if limits have been exceeded or undershot. Inactive limits are indicated with "_".



8.4 Setting the outputs



	MANIPULATION	ADDITIONAL INFO / IMAGES
1.	Press the Menu button.	
2.	Enter the access code and confirm with OK .	i Factory setting is 0 .
3.	Press the Inp./outputs button.	i If the desired menu does not appear, press the arrow at the bottom right.
4.	Press the Outputs button.	
5.	Select O1 Inactive .. O7 Inactive Output .	
6.	Activate the outputs (multiple selection possible).	<p>Activated outputs are highlighted green.</p> <ul style="list-style-type: none"> ▪ Invert: Inverts the outputs ▪ Prio fault ▪ Fault ▪ Warning ▪ Service ▪ Adjustment ▪ Sensor check ▪ Humidity ▪ Limit 1 .. 4 <p>The other buttons named MR-Out... are for automatic measuring range switching → Reference Handbook.</p>
7.	Press the Meas button.	The instrument is in measuring mode again.





8.5 Activating the optional flow meter



	MANIPULATION	ADDITIONAL INFO / IMAGES
1.	Press the Menu button.	
2.	Enter the access code and confirm with OK .	i Factory setting is 0 .
3.	Press the Ana. channels button.	i If the desired menu does not appear, press the arrow at the bottom right.
4.	Select A1 Inactive .	
5.	During measurement, press the Inactive button so that Active is now displayed.	
6.	Press the Meas button.	The instrument is back in measuring mode. The flow rate is now displayed (press the arrow at the bottom right, if necessary)

8.6 Setting the date and time





	MANIPULATION	ADDITIONAL INFO / IMAGES
1.	Press the Menu button.	
2.	Enter the access code and confirm with OK .	 Factory setting is 0 .
3.	Press the Configuration button.	 If the desired menu does not appear, press the arrow bottom right.
4.	To enter the time, press the currently displayed time at the Time menu item and enter the new time with the number pad. Confirm entry with OK .	The time must be entered in the format hh:mm:ss . 
5.	To enter the date, press the currently displayed date at the Date menu item and enter the new date with the number pad. Confirm entry with OK .	The date must be entered in the format selected under the Date format menu item. 
6.	Press the Meas button.	The instrument is in measuring mode again.

8.7 Setting or changing the access code

You can protect the settings of the instrument against unauthorized manipulations by defining your own access code.



	MANIPULATION	ADDITIONAL INFO / IMAGES
1.	Press the Menu button.	
2.	Enter the access code and confirm with OK .	 Factory setting is 0 .
3.	Press the Configuration button.	 If the desired menu does not appear, press the arrow bottom right.
4.	Press the button to the right of the Access code description text.	
5.	Enter the access code and confirm with OK .	
6.	Press the Meas button.	The instrument is in measuring mode again.



A forgotten access code can be cleared only by a SIGRIST service engineer.

Enter your personal access code here:

--	--	--	--	--	--

8.8 Backup configured data

These measures can be of use to the service engineers for service purposes.



	MANIPULATION	ADDITIONAL INFO / IMAGES
1.	Press the Menu button.	
2.	Enter the access code and confirm with OK .	i Factory setting is 0 .
3.	Press the System info. button.	i If the desired menu does not appear, press the arrow bottom right.
4.	In the User -> SD and Expert -> SD submenus press the Copy function.	The user and expert data are copied to the microSD card. After a successfully completed procedure, acknowledge with the OK button.
5.	Press the Meas button.	The instrument is in measuring mode again.

9 Servicing



CAUTION!

Damage to the instrument due to servicing duties that have not been carried out or have been carried out improperly.

If servicing duties are not carried out according to the servicing schedule or non-original SIGRIST spare parts are used, this can lead to damage to the instrument or measuring errors. In this case, SIGRIST-PHOTOMETER AG accepts no warranty claims made by the customer and is not responsible for any subsequent costs. To avoid this situation, please adhere to the following steps:

- Carry out servicing duties according to the servicing schedule (Section 9.1).
- When carrying out servicing duties, use original SIGRIST spare parts according to the spare parts list (Section 15). The use of third-party spare parts requires the written approval of SIGRIST-PHOTOMETER AG.
- If the instruments are subjected to heavy use or exposed to severe environmental conditions, servicing duties must be carried out more often as required. Wear parts in particular must be replaced more often depending on the circumstances.

9.1 Servicing schedule

WHEN	WHO	WHAT	PURPOSE
Annually or as needed	Operator	Clean the measuring cell. Section 9.2	Obligatory measure for maintaining measuring accuracy. Interval dependent on measuring medium.
Annually or in the event of a warning	Operator	Replace the desiccant. Section 9.3	Obligatory measure for maintaining measuring accuracy.
Every 3 months or more often (as needed)	Operator	Recalibration of the photometer. Section 9.4	Measure for maintaining measuring accuracy. Interval dependent on measurement surroundings.
Annually or as needed	Operator	Carry out the sensor check. Section 9.5	Obligatory measure for maintaining measuring accuracy.
Annually or as needed	Operator	Replace the water filter (only on instruments with a water filter unit). Section 9.6	Obligatory measure for maintaining measuring accuracy and functional efficiency. Interval dependent on measuring medium.
Every 10 years or as needed	Operator	Replace the battery in the SICON. Section 9.7	Obligatory measure for maintaining functional efficiency.
Annually or as needed	Operator	Clean the outside of the instrument.	Dirt on the outside of the photometer does not have any effect on the measuring results. Cleaning is thus not absolutely essential.





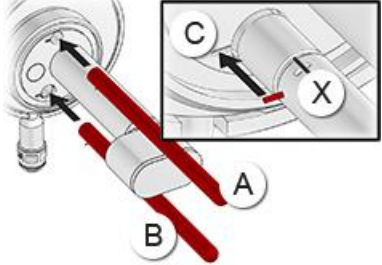

Table 1: Servicing schedule

9.2 Cleaning the measuring cell

The following procedure describes how to clean the measuring cell and measuring cell windows on the ColorPlus 3:







	WORKSTEP	ADDITIONAL INFO / IMAGES
1.	Stop the sample flow and let the measuring cell run dry.	
2.	Interrupt the service voltage to the photometer. ⚠ Eye injuries caused by UV radiation. The instrument uses a xenon flash lamp. The light pulses are intense and the wavelength spectrum extends from UV to IR. <ul style="list-style-type: none"> ▪ Always interrupt the service voltage before opening the instrument. ▪ Never look directly into the light beam. ▪ Do not use any reflective objects when cleaning the measuring cell. 	
3.	Loosen the screw cap and remove it from the ColorPlus 3 together with the cap.	
4.	Pull out the sample distributor (A) and outlet pipe (B) and clean with a bottle brush.	

	WORKSTEP	ADDITIONAL INFO / IMAGES
5.	<p>Clean the four measuring cell windows (arrows) with ethanol.</p> <p> Do not use abrasive cleaning agents.</p>	
6.	<p>Remove the remaining part of the measuring cell.</p>	
7.	<p>Grease the gaskets on the sample distributor and outlet pipe (position X).</p> <p> Check the gasket on the sample distributor (8 x 1) and outlet pipe (6 x 1) and replace if necessary.</p> <p>Insert the sample distributor (B) and outlet pipe (A) back in the bores.</p> <p> Ensure that the pins are aligned to the slots (see C) and that the outer diameters of the sample distributor and outlet pipe are different.</p>	
8.	<p>Screw the cap and screw cap onto the measuring cell.</p>	

9.3 Replacing the desiccant

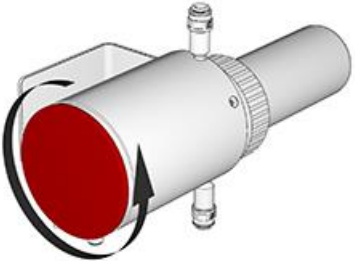
The following procedure describes how to replace the desiccant in the ColorPlus 3:

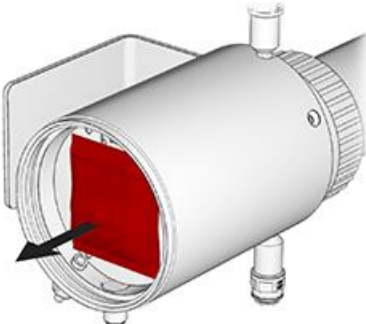

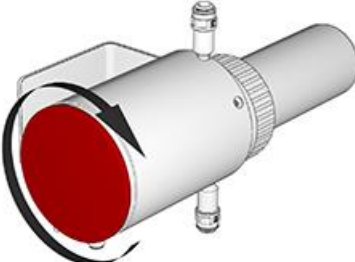
	WORKSTEP	ADDITIONAL INFO / IMAGES
1.	Unscrew the cover on the ColorPlus 3.	
2.	Replace the old desiccant bag with a new one.  Check the gasket on the cover (88 x 2). Replace this, if necessary.	
3.	Screw the cover back onto the ColorPlus 3 immediately.  The humidity sensor is located in the receiver. Therefore, the humidity measurement only reacts slowly to new desiccant (2% to 3% per hour).	

9.4 Recalibrating the photometer



Recalibrating the photometer can result in deviations from the previous measuring value as the instrument is newly reset to a reference value (e.g. distilled water).



	WORKSTEP	ADDITIONAL INFO / IMAGES
1.	Fill the measuring cell with a zero medium (distilled water).	There must be no air bubbles in the measuring cell during recalibration (low flow, light counter pressure).
2.	2.1: Press the Menu button.	
	2.2: Enter the access code and confirm with OK .	Factory setting is 0 .
	2.3: Select the Recalibration menu and then press C1 . Check whether the nominal value is correct. On instruments with several channels, press the ESC button and check the nominal value on all other channels. Go back to the C1 menu.	Typically, the nominal value is set to 0.00 E on instruments that measure in absorbance (Meas. channels\Channel n\Lin/Log on Log). The nominal value is set to 100.0 % on instruments that measure in transmittance (Meas. channels\Channel n\Lin/Log on Lin). On the nitrate instrument, the nominal value is 0.000 mg/l .
	2.4: Press the initiate... button. Recalibration of all channels is made simultaneously. If the adjustment was successful, this is confirmed with Adjustment OK . Recalibration is now complete. If the adjustment was not successful, this is indicated with Adjust. fault . In this case, check the points in the following list one after the other: <ul style="list-style-type: none"> ▪ Instrument mounted correctly? ▪ Soiling of the instrument too heavy? ▪ Air bubbles in the measuring cell? ▪ Correct nominal values set? ▪ Correct zero medium used? 	If the check could not be successfully completed, contact your country representative.

9.5 Carrying out the sensor check

The sensor check is an internal functional check of the photometer that is carried out automatically once a week as standard. This period can be set freely or deactivated completely (**Menu\Spec. function\Check interv.**).

Independently of this automatic process, a sensor check can be started at any time manually or via an external control signal. → Reference Manual

During the functional check, a 100% value is determined first. An optical filter is then moved into the light beam and the resulting attenuation defined.



	MANIPULATION	ADDITIONAL INFO / IMAGES
1.	Press the Menu button.	
2.	Set the access code and confirm with OK .	 Factory setting is 0 .
3.	Press the Sensor check button.	
4.	Press the start... button.	First, the following message appears: 100% run... The display then changes to: running...
5.	If the check is successful, Check OK is displayed. The actual value now has to match the nominal value (+/- tolerance). If the check is not successful, Check fault is displayed.	Possible causes of Check fault : <ul style="list-style-type: none"> ▪ Too much external light. ▪ Housing removed. ▪ Excessive absorption in the measuring cell. ▪ Optics soiled. ▪ Defect in the electronic system.
6.	Press the Meas button.	The instrument is back in measuring operation.

9.6 Replacing the filter cartridge on the filter unit

Only carry out this servicing duty on instruments with an optional filter unit.



Figure 23: Filter unit

①	Filter unit	②	Union nuts
③	Filter housing with fine filter: 0.5 µm (DOC 254) 0.3 µm (Nitrate)	④	Filter housing with coarse filter 20 µm

The following procedure describes how to replace the water filter on the filter unit:



	WORKSTEP	ADDITIONAL INFO / IMAGES
1.	Stop the sample feed.	
2.	Remove the union nut (Figure 23, pos. 2) using the supplied special wrench.	
3.	Remove the corresponding filter housing (Figure 23, pos. 3/4) and replace the old filter cartridge with a new one.	
4.	Fasten the corresponding filter housing (Figure 23, pos. 3/4) back in place on the filter unit (Figure 23, pos. 1) with the union nut (Figure 23, pos. 2) using the special wrench.	i Ensure that the seal on the filter housing is correctly mounted.
5.	The instrument is now ready for operation again.	

9.7 Changing the battery in the SICON (M)



DANGER!



Life-threatening voltage inside the instrument.
 Connecting electrical lines can be extremely dangerous. Instrument parts may also be damaged. Local regulations for electrical installations must be observed at all times.

	WORKSTEP	ADDITIONAL INFO / IMAGES
1.	Interrupt the service voltage to the SICON (M).	
2.	Open the SICON (M) according to Section 5.2.	
3.	Remove the battery (circle).	
4.	Insert the new battery.	
5.	Close the SICON (M).	
6.	Re-establish the service voltage.	
7.	Set the date and time.	

10 Troubleshooting

10.1 Pinpointing faults

DETECTABLE FAULT	MEASURE
No reading	<ul style="list-style-type: none"> Check whether the supply voltage is connected. Check whether the mains plug is connected. Check whether the instrument is switched on.
Fault message in the display	<ul style="list-style-type: none"> Analyze the fault message according to Section 10.1.2.
The reading appears to be wrong	<ul style="list-style-type: none"> Ensure that the sample to be measured corresponds to the operating conditions. Section 2.4 Carry out recalibration. Section 9.4 Check whether the instrument is correctly mounted. Section 4 Ensure that the servicing duties have been performed according to the servicing schedule. Section 9.1

Table 2: Pinpointing malfunctions



If the listed measures do not lead to the desired results, please consult customer service. Section 11

10.1.1 Warning messages and effect on operation

Warnings indicate an unusual state.

WARNINGS	
<p>If a warning occurs during operation, it has the following effects:</p> <ul style="list-style-type: none"> The system continues to operate. However, the measuring results must be evaluated with caution. The cause of the warning message should be remedied at the next possible opportunity. When the cause of the warning has been remedied, it is automatically deleted. When the Warning message occurs, the color of the status display changes to orange and the warning text describes the warning in question. 	<p>Example: WARNING CURRENT 1</p>

The following warning messages can be displayed:

WARNING MESSAGE	DESCRIPTION	POSSIBLE CAUSES
V IN	The input voltage is outside the permitted range (20 .. 26.5 VDC).	<ul style="list-style-type: none"> ▪ The service voltage is faulty.
ADJUST FAULT	Recalibration could not be carried out.	<ul style="list-style-type: none"> ▪ The instrument is soiled. ▪ The nominal value for the adjustment does not match the value of the medium.
SENSOR CHECK	The automatic sensor check failed.	<ul style="list-style-type: none"> ▪ Too much external light. ▪ Housing removed. ▪ Excessive absorption in the measuring cell. ▪ Optics soiled. ▪ Defect in the electronic system.
SOILING	The soiling level is greater than the set limit.	<ul style="list-style-type: none"> ▪ The measuring cell is soiled and has to be cleaned.
NEGATIVE VAL	Warning in the event of negative absorbance values. The measuring value is smaller than the set limit.	<ul style="list-style-type: none"> ▪ The last recalibration was incorrect. ▪ Also possible on instruments with soiling compensation in the event of very heavy soiling.
OVER TEMP	The temperature in the instrument has exceeded 65 °C.	<ul style="list-style-type: none"> ▪ The medium or ambient temperature is too high and defective/no cooling.
HUMIDITY	The relative humidity in the instrument has risen above the set limit.	<ul style="list-style-type: none"> ▪ The desiccant is saturated. ▪ The gaskets on the electronic component are defective. ▪ The instrument was open for a long period.
AN.MEAS.FAULT	The measuring value acquisition of the analog channels is disturbed.	<ul style="list-style-type: none"> ▪ Defect in the electronic system. → Service technician
ANALOG IN 1/2	The input signal on analog input 1/2 is less than the error limit.	<ul style="list-style-type: none"> ▪ There is no input signal.
CURRENT 1 .. 8	Current output 1 .. 8 is disturbed.	<ul style="list-style-type: none"> ▪ Terminals are open. ▪ Interruption of the current loop of the measuring value output.
TEMP.SENSOR	The inner temperature sensor failed.	<ul style="list-style-type: none"> ▪ Defect in the electronic system. → Service technician
EXTERNAL ON (Name ext.in.)	An external event is signaled via a digital input.	<ul style="list-style-type: none"> ▪ External malfunction.

WARNING MESSAGE	DESCRIPTION	POSSIBLE CAUSES
SERVICE	Shows when service work is due.	<ul style="list-style-type: none"> Service work is due.
VERS.SD CARD	The data on the microSD card does not match the current software.	<ul style="list-style-type: none"> Update was performed incorrectly.
WATCHDOG	The internal fault monitoring has been actuated. The program has been re-started.	<ul style="list-style-type: none"> Program crash.

Table 3: Possible warning messages

10.1.2 Fault messages and effect on operation

FAULT	
<p>If a fault occurs during operation, it has the following effects:</p> <ul style="list-style-type: none"> A fault is a malfunction which prevents correct measurement value acquisition. The measuring values of the concerned photometer go to 0. Assigned current outputs go to the programmed electrical current If fault. Assigned limits are deactivated. When the Fault message appears, the color of the status display changes to red and the text describes the fault in question. If an output for faults is programmed, it is activated. 	 <p>Example: FAULT SERIAL 1</p>

The following fault messages can be displayed:

FAULT MESSAGE	DESCRIPTION	POSSIBLE CAUSES
SLAVE SW VERS	The software version of the photometer does not match that of the control unit.	<ul style="list-style-type: none"> Different delivery data on instrument and control unit. Carry out a slave update. → Reference Handbook
SERIAL 1	The control unit cannot establish a connection to the photometer.	<ul style="list-style-type: none"> Interrupted connection to the photometer. Defect in the electronic system. → Service technician
V ANALOG	One of the internal analog voltages is outside the permitted range.	<ul style="list-style-type: none"> Defect in the electronic system. → Service technician

FAULT MESSAGE	DESCRIPTION	POSSIBLE CAUSES
MEASUR. FAULT	Measuring value acquisition is faulty.	<ul style="list-style-type: none"> ▪ Bubbles in the water. ▪ External light in the vicinity of the measuring point (e.g. transparent hoses). ▪ Defect in the electronic system. → Service technician
LIGHT SOURCE 1 .. 3	The detector for monitoring the light source receives no light from the corresponding light source.	<ul style="list-style-type: none"> ▪ Defective light source. → Service technician
HUMIDITY	The relative humidity in the instrument has risen above 50%.	<ul style="list-style-type: none"> ▪ The desiccant is saturated. ▪ The gaskets on the electronics component are defective. ▪ The instrument was open for a long period.
MASTER SW VERS	This fault message is displayed when the software version of the SICON is older than the version of the connected photometer.	<ul style="list-style-type: none"> ▪ Software is not the most recent version. In this case, the software of the control unit must be updated to the most recent version. → Reference Handbook
POWERBOX	Actuation of the power box has been disturbed.	<ul style="list-style-type: none"> ▪ Connection to the power box has been interrupted.
IO PORT	The connection between NG_Haupt and NG_Bedi-Print in the SICON has been disturbed.	<ul style="list-style-type: none"> ▪ Cable disconnected. ▪ Plug connection defective.

Table 4: Possible fault messages

10.1.3 Prioritized fault messages and their effect on operation



CAUTION!

When there is a prioritized fault, the cause of the malfunction is serious.

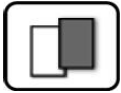

<p>PRIO (PRIORITIZED FAULT)</p> <p>If a prioritized fault occurs during operation, it has the following effects:</p> <ul style="list-style-type: none"> ▪ The measuring values go to 0. ▪ Prioritized faults can be cleared only by a service engineer. ▪ When the Prio message occurs, the color of the status display changes to red and the text describes the prioritized fault in question. 	 <p>Example: PRIO DEFAULT VALUES</p>
--	--

The following prioritized fault messages can be displayed:

PRIO MESSAGE	DESCRIPTION	POSSIBLE CAUSES
DEFAULT VALUES	The default values were loaded.	<ul style="list-style-type: none"> ▪ If no parameters were initialized or if all parameters were lost, the default values are loaded.
CRC EXPERTS	A fault was determined when the expert data was checked.	<ul style="list-style-type: none"> ▪ Electromagnetic malfunctions. ▪ Defect in the electronic system.
CRC USER	A fault was determined when the user data was checked.	<ul style="list-style-type: none"> ▪ Electromagnetic malfunctions. ▪ Defect in the electronic system.
CRC DISPLAY	A fault was determined when the display data was checked.	<ul style="list-style-type: none"> ▪ Electromagnetic malfunctions. ▪ Defect in the electronic system.
EXT RAM	A fault was determined when the RAM in the graphic controller was checked.	<ul style="list-style-type: none"> ▪ Defect in the electronic system.
SW VERS	Software which is unsuitable for this instrument type was loaded.	<ul style="list-style-type: none"> ▪ Faulty software update. → Service technician

Table 5: Possible prioritized fault messages

11 Customer service information

Should you have any questions, please contact the responsible service center in your country or region. If this is not known, SIGRIST-PHOTOMETER AG customer service in Switzerland would be glad to provide you with a contact address.

A current list of all SIGRIST country representatives is available online at www.photometer.com.

Please have the following information ready when you contact a SIGRIST service point or customer service:

- The serial numbers of the connected instruments.
- A description of instrument behavior and the work steps when the problem occurred.
- A description of what you did when trying to solve the problem yourself.
- The documentation of the third-party products you use in conjunction with the ColorPlus 3.
- Description of operation conditions (place, power supply, measured medium, temperature etc.)
- Application and Instruction Manual.

12 Decommissioning/Storage

12.1 Decommissioning the photometer

The aim of decommissioning is to prepare the individual components of the system properly for storage.



	WORKSTEP	ADDITIONAL INFO / IMAGES
1.	Interrupt the service voltage to the instrument.	
2.	Stop the sample flow and let the measuring cell run empty.	
3.	Remove the electrical connections on the control unit.	Section 5
4.	Remove the control unit and pack for storage.	
5.	Remove the instrument.	
6.	Clean and dry the instrument.	
7.	Clean and dry the measuring cell.	
8.	Close all openings on the photometer.	
9.	Close all openings on the measuring cell.	

12.2 Storing the photometer

There are no special requirements for storing the instruments. However, please note the following information:

- The system contains electronic components. Storage for such components must fulfill the usual conditions. It is important to note that the storage temperature must be between -20 and +50 °C.
- All components that come into contact with the sample during operation have to be dry and clean for a long time before being put into storage.
- The measuring equipment with all of the accessory parts must be protected against weather factors, condensing humidity and aggressive gases during storage.

13 Packaging / Transport / Returning



DANGER!

Injuries to persons due to hazardous media residues in the returned instrument.

Instruments that have come into contact with hazardous media may not be sent without the appropriate information on the corresponding repairs or professional decontamination (see RMA form).

- Precise information on the medium must be received by SIGRIST-PHOTOMETER in advance of the instrument to be repaired so that the necessary precautions can be taken when unpacking it.

The original packaging materials should be used for packaging the ColorPlus 3 if possible. If the original packaging is no longer available, note the following information:

- Before packaging, close the openings of the instrument with adhesive tape or plugs so that no packaging materials can enter the instrument.
- The instrument contains optical and electronic components. Make sure that the packaging protects the instrument from being damaged by impacts during transport.
- All peripheral devices and accessory parts must be packaged separately and marked with the serial number of the photometer (Section 2.2). This prevents confusion and mix-ups later while also making it easier to identify parts.
- A RMA form (14711E) must be filled in and enclosed for all returned instruments and spare parts. This can be downloaded at www.photometer.com.

When packaged as described above, the instruments can be transported via all usual shipping methods.

14 Disposal



Disposal of the system and its peripheral devices is to be carried out in compliance with regional statutory regulations.

The system has no environmentally damaging sources of radiation. The materials listed below should be disposed of or recycled as described in the following table:

CATEGORY	MATERIALS	DISPOSAL POSSIBILITIES
Packaging	Cardboard, wood, paper	Reuse as packaging material, local disposal center, incineration plants.
	Protective foils, polystyrene shells	Reuse as packaging material, recycling.
Electronics	Circuit boards, electromechanical components, display, touchscreen, transformer and cables	To be disposed of as electronic waste.
Parts which come into contact with water	PVC	Local disposal center.
	POM	Local disposal center.
	Stainless steel	Waste metal disposal centers.
Optics	Glass, aluminum	Local disposal center.
Filter and lens holder	Aluminum	Waste metal disposal center.
Battery	Lithium	Recycling via locally organized collection point.
Xenon lamp	Metal, glass, electronics	Special waste.
Photometer housing	Stainless steel	Waste metal disposal center.
Desiccant	Rubingel	Normal waste disposal (chemically safe).

Table 6: Materials and their disposal

15 Spare parts list

The parts mentioned in this documentation and their article numbers are listed in the following table:

NO. ARTICLE	DESIGNATION	REMARQUES
111391	Desiccant bag, 30 g	
118265	O-ring FPM 88 x 2	
120958	O-ring EPDM 50.39 x 3.53	
121016	Sample distributor	100 mm measure cell
121164	Sample distributor	50 mm measure cell
121159	Sample distributor	Nitrate measure cell
118267	O-ring silicone 8 x 1	For sample distributor
121017	Outlet pipe	100 mm measure cell
121065	Outlet pipe	50 mm measure cell
121160	Outlet pipe	Nitrate measure cell
120957	O-ring silicone 6 x 1	For outlet pipe
120986	Plastic push-in connections, D = 8 mm on G 1/4" outer thread	Sample inlet/outlet
120925	PVC cap	100 mm measure cell
120926	PVC cap	50 mm measure cell
120927	PVC cap	Nitrate measure cell
120936	PVC screw cap	
111834	Battery 3V CR 2032 (button battery)	For SICON
108876	Filter cartridge 0,5 µm	DOC device
120060	Filter cartridge 20 µm	DOC and Nitrate device
121857	Filter cartridge 0,3 µm	Nitrate device

Table 7: Spare parts

16 Index

4

4-way current input35
 4-way current output34

A

Access code, set56
 Analog modules34
 Article numbers76

B

Back up fuse22
 Battery, SICON66

C

Cable cross-section27
 Cable ties30
 CE mark8
 Cleaning the measuring cell59, 60
 Cleaning the outside of the instrument59
 Commissioning36
 Configuring the current outputs50
 Conformity of the product8
 Connection box27
 Connection, mains device30
 Current modules34
 Customer service72

D

Danger symbols on the instrument18
 Dangers9, 17
 Date and time55
 Decommissioning73
 DIL switch25
 Directives8
 Disposal75
 Documentation, additional7

E

Electrical installation
 Power 22
 Environmental damage75
 Ethernet connection24

F

Fault69

Flow meter 29, 54

G

Glossary 7

H

HART 33

I

Improper use 9
 Initial start-up 36
 Installation 20
 Installation position 20
 Installation, longer distances 27
 Internet security 19

L

Language 49
 Log screen 42

M

Mains device 30
 Mains switch 22
 Modbus RTU 31
 Mounting 20

O

Operation 37

P

Parts overview 76
 Pictograms 10
 Pinpointing faults 67
 Power supply 30
 Prioritized fault messages 71
 Products overview 11
 Profibus DP 31
 Profinet IO 32
 Proper use 8
 Protect, settings 56
 Protective conductor 22
 Purpose of the document 7

R

Rating plate 12
 Recalibration 59, 63

Replacing the desiccant.....59, 62
Replacing the water filter59, 65
Residual risk 18

S

Safety symbols 10
Save data57
Scope of supply, standard 13
Screen lock44
SD card adapter24
Sensor check59, 64
Service center.....72
Service mode45
Servicing duties59
Setting the current outputs50
Setting the limits51
Setting the outputs53
SICON (M).....23, 25
SICON M, overview24
SICON terminal block25
Spare parts.....76
Storage7, 73

T

Target group of the document 7
Technical data 15
Terms, glossary..... 7
Touchscreen 37
Transport 74
Troubleshooting 67

U

USB connection 24
Use restrictions 8
User requirements 8

W

Warning messages 67
Warning symbols on the instrument 18
Warnings 17
Web user interface 36

SIGRIST-PHOTOMETER AG
Hofurlistrasse 1
CH-6373 Ennetbürgen
Switzerland

Tel. +41 41 624 54 54
Fax +41 41 624 54 55
info@photometer.com
www.photometer.com